

**Features:**

- packaged pumping station made of corrosion-resistant PE-LLD
- buoyancy-proof up to ground water level of max. 1,2 m from manhole's lower edge
- installation of one pump of the series ZFS 71, ZPG 50, ZPG 71
- stainless steel piping DN 50, pre-assembled with coupling system
- non-return valve, gate valve and flushing connection 1"
- pressure outlet PE-HD 63 x 5.8 – outside the manhole
- 1 x inlet DN 150, further inlets optional
- 2x connection DN 100 for cable gland and air vent

**Application:**

- pumping of sewage from single-family houses
- as drainage pumping station
- for pressure drainage
- for installation outside buildings
- also drivable with manhole covers class B and D

**Scope of delivery:**

- pumping station with pressure pipes and valves
- ZFS 71 series - grinder pump (except Art.no. 14483)
- BEGU manhole cover class A-D optional (see accessories)
- control unit ZPS for pumping station (ZPG 50 WA with float switch)

**Product benefits:**

- complete pumping station for domestic connections (1 pump)
- complete set - ready for connection available
- load capacity up to 40 tons (class D)
- divers pump options (e.g. ZFS 71, ZPG 50, ZPG 71)
- made of corrosion-resistant PE-LLD for lifelong operating time
- pre-assembled connections available
- quick-coupling system for easy pump insertion and optimal sealing

**Technical data:**

Art.no.	U [V]	P <sub>1</sub> [W]	P <sub>2</sub> [W]	In [A]	n [min <sup>-1</sup> ]	Q <sub>max</sub> [m <sup>3</sup> /h]	H <sub>max</sub> [m]	P0	D [mm]	L [mm]	W [mm]	H [mm]	Weight [kg]
21369	400	2.100	1.700	3,7	2800	17,0	22,0	DN 50	1100	1100	1100	2230	200

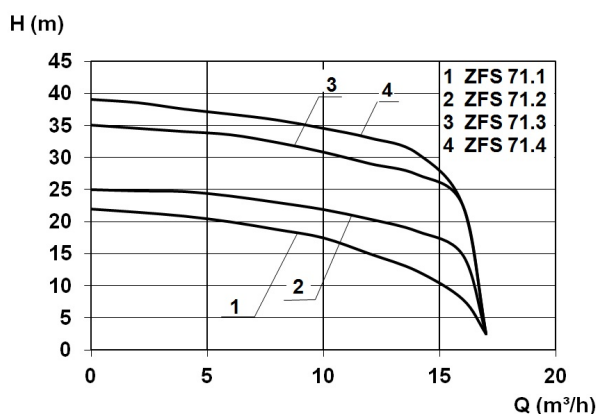
**Characteristics:**

**Materials:**

Material impeller:	PA6 GV25
Seal motor:	mechanical seal SIC/SIC/NBR
Seal pump:	mechanical seal SIC/SIC/NBR
Material motor housing:	cast-iron GG25
Material pump housing:	cast-iron GG25
Material motor shaft:	stainless steel AISI 420
Material container:	PE

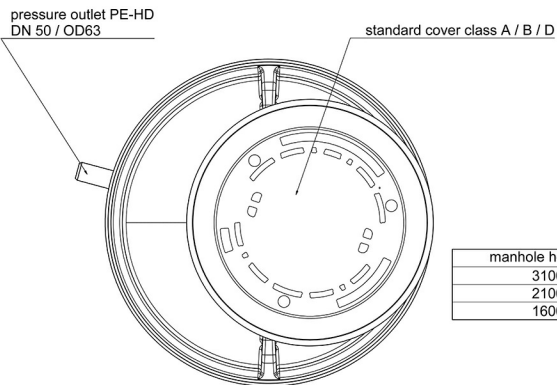
**Dimensions:**



manhole height: H	X
3100	2675
2100	1675
1600	1175