

Features:

- packaged pumping station made of corrosion-resistant PE-LLD
- buoyancy-proof up to ground water level of max. 0,5 m from manhole's lower edge
- installation of one pump of the series ZFS 71, ZPG 50, ZPG 71
- stainless steel piping DN 32, pre-assembled with coupling system
- non-return valve, gate valve and flushing connection 1"
- pressure outlet PE-HD 63 x 5.8 – outside the manhole
- 1 x inlet DN 150, further inlets optional
- 2x connection DN 100 for cable gland and air vent

Application:

- pumping of sewage from single-family houses
- as drainage pumping station
- for pressure drainage
- for installation outside buildings
- also drivable with manhole covers class B and D

Scope of delivery:

- pumping station with pressure pipes and valves
- ZFS 71 series - grinder pump (except Art.no. 14483)
- BEGU manhole cover class A-D optional (see accessories)
- control unit ZPS for pumping station (ZPG 50 WA with float switch)

Product benefits:

- complete pumping station for domestic connections (1 pump)
- complete set - ready for connection available
- load capacity up to 40 tons (class D)
- divers pump options (e.g. ZFS 71, ZPG 50, ZPG 71)
- made of corrosion-resistant PE-LLD for lifelong operating time
- pre-assembled connections available
- quick-coupling system for easy pump insertion and optimal sealing

Technical data:

Art.no.	U [V]	P ₁ [W]	P ₂ [W]	In [A]	n [min-1]	Q _{max} [m ³ /h]	H _{max} [m]	SH [mm]	PO	D [mm]	L [mm]	W [mm]	H [mm]	Weight [kg]
21615	400	2.050	1.500	3,5	2800	29,0	16,1	45	DN 50	1100	1100	1100	1730	130

Characteristics:

Materials:

Material impeller:	cast-iron GG25
Seal motor:	shaft seal SIC/SIC/NBR
Seal pump:	mechanical seal SIC/SIC/NBR
Material motor housing:	cast-iron GG25
Material pump housing:	cast-iron GG25
Material motor shaft:	stainless steel AISI 420
Material container:	PE

Dimensions:

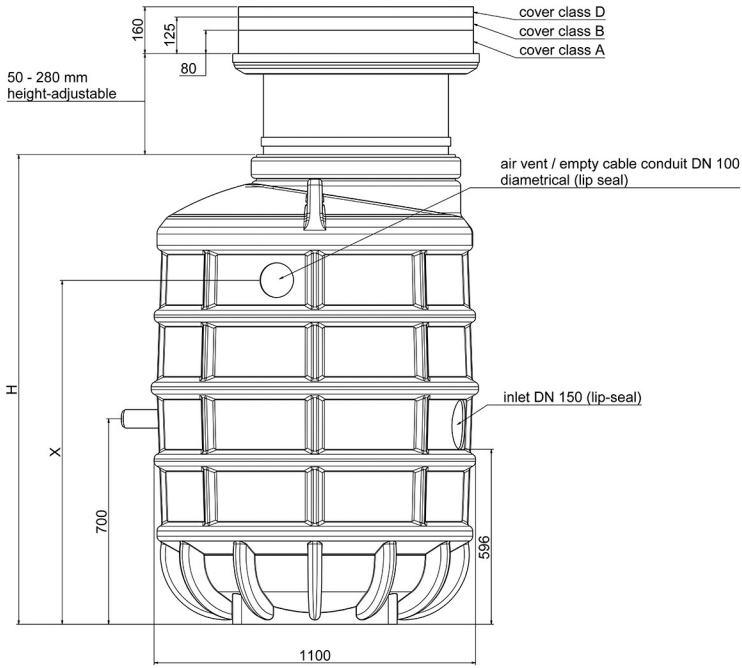

pressure outlet PE-HD
DN 50 / OD63

standard cover class A / B / D

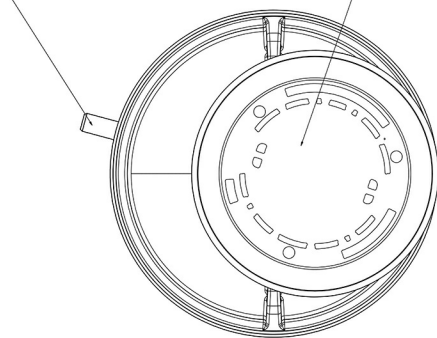

manhole height: H	X
3100	2675
2100	1675
1600	1175