

**Features:**

- Fully automatic pressure boosting system
- Speed controlled
- Base plate version
- Membrane pressure vessel approved for drinking water on the pressure side as a control vessel, flow through according to DIN 4807-5, with stopcock and drainage valve
- vertical high-pressure pumps with speed control
- Reliable operation due to hydraulic components made of stainless steel / brass
- Check valve
- Pressure gauge for pressure indication
- Electronic dry run protection
- Pressure sensor on both sides
- Vibration damping
- Electric motor, protection class IP55, efficiency class IE5 according to IEC 60034-30
- Error message contact per pump

**Application:**

- Pressure increase
- Pumping of drinking water, process water, cooling water & liquids that do not chemically or mechanically attack the materials

**Scope of delivery:**

- Pump with control
- Expansion tank
- Base plate for safe installation



**Product benefits:**

- Energy-efficient operation and constant pressure through speed control of the pump
- Suitable for drinking water through production under strict hygienic conditions
- Simple and fast commissioning due to ready-to-connect, pre-assembled and tested system
- Corrosion-resistant due to powder-coated materials and stainless steel
- Operational safety due to built-in dry-running protection
- Avoidance of damage to the piping system in the 3~400 V version through piping filling function
- Remote monitoring of the plant through connection to building control system

**Technical data:**

Art.no.	U [V]	P <sub>1</sub> [W]	I <sub>n</sub> [A]	n [min <sup>-1</sup> ]	Q <sub>max</sub> [m <sup>3</sup> /h]	H <sub>max</sub> [m]	P <sub>O</sub>	L [mm]	W [mm]	H [mm]	Weight [kg]
21894	400	370	1,3	2900	6,5	17	G 11/4	503	170	579	55

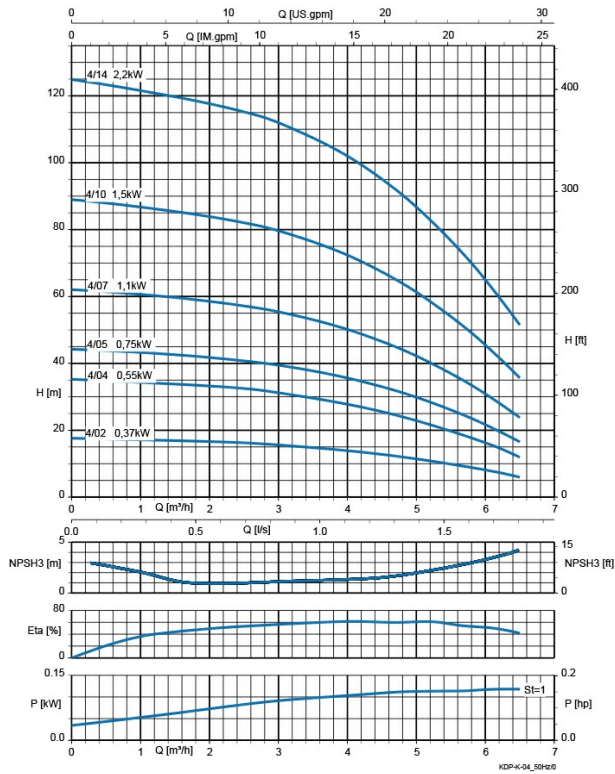
**Characteristics:**



**Materials:**

Seal motor:	mechanical seal
Material pump housing:	stainless steel 1.4308

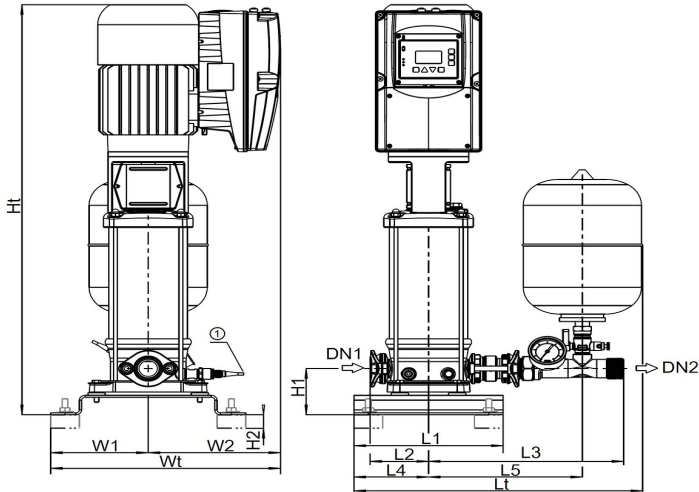
**Dimensions:**

Pump(s)	Type	Stages	DN 1 [mm]	DN 2 [mm]	L1 [mm]	L2 [mm]	L3 [mm]	L4 [mm]	L5 [mm]	Lt [mm]	H1 [mm]	H2 [mm]	Ht [mm]	W1 [mm]	W2 [mm]	Wt [mm]
1	02	05	G 1 1/4	G 1 1/4	260	102	340	130	268	503	95	28	643	170	220	390
1	02	08	G 1 1/4	G 1 1/4	260	102	340	130	268	503	95	28	718	170	220	390
1	02	10	G 1 1/4	G 1 1/4	260	102	340	130	268	503	95	28	761	170	235	405
1	02	14	G 1 1/4	G 1 1/4	260	102	340	130	268	503	95	28	847	170	235	405
1	04	02	G 1 1/4	G 1 1/4	260	102	340	130	268	503	95	28	579	170	220	390
1	04	04	G 1 1/4	G 1 1/4	260	102	340	130	268	503	95	28	622	170	220	390
1	04	05	G 1 1/4	G 1 1/4	260	102	340	130	268	503	95	28	653	170	235	405
1	04	07	G 1 1/4	G 1 1/4	260	102	340	130	268	503	95	28	698	170	235	405
1	04	10	G 1 1/4	G 1 1/4	260	102	340	130	268	503	95	28	783	170	240	210
1	04	14	G 1 1/4	G 1 1/4	260	102	340	130	268	503	95	28	893	170	230	400
1	06	02	G 1 1/4	G 1 1/4	260	102	340	130	268	503	95	28	586	170	220	390
1	06	03	G 1 1/4	G 1 1/4	260	102	340	130	268	503	95	28	621	170	235	405
1	06	05	G 1 1/4	G 1 1/4	260	102	340	130	268	503	95	28	671	170	235	405
1	06	07	G 1 1/4	G 1 1/4	260	102	340	130	268	503	95	28	743	170	240	410
1	06	10	G 1 1/4	G 1 1/4	260	102	340	130	268	503	95	28	842	170	230	400
1	06	14	G 1 1/4	G 1 1/4	260	102	340	130	268	503	95	28	982	170	240	410
1	10	02	G 1 1/2	G 1 1/2	340	129	379	170	309	584	125	28	666	190	235	425
1	10	03	G 1 1/2	G 1 1/2	340	129	379	170	309	584	125	28	692	190	235	425
1	10	04	G 1 1/2	G 1 1/2	340	129	379	170	309	584	125	28	741	190	240	430
1	10	06	G 1 1/2	G 1 1/2	340	129	379	170	309	584	125	28	818	190	230	420
1	10	08	G 1 1/2	G 1 1/2	340	129	379	170	309	584	125	28	911	190	240	430
1	10	11	G 1 1/2	G 1 1/2	340	129	379	170	309	584	125	28	1011	190	255	445
1	15	02	G 2	G 2	340	129	379	170	309	584	125	28	688	190	230	420
1	15	03	G 2	G 2	340	129	379	170	309	584	125	28	778	190	240	430
1	15	04	G 2	G 2	340	129	379	170	309	584	125	28	826	190	255	445
1	15	06	G 2	G 2	340	129	379	170	309	584	125	28	981	190	310	500
1	15	08	G 2	G 2	340	129	379	170	309	584	125	28	1093	190	330	520