

Features:

- Fully automatic pressure boosting system
- Speed controlled
- Base plate version
- Membrane pressure vessel approved for drinking water on the pressure side as a control vessel, flow through according to DIN 4807-5, with stopcock and drainage valve
- 2 vertical high-pressure pumps with speed control
- Reliable operation due to hydraulic components made of stainless steel / brass
- Check valve for each pump
- Pressure gauge for pressure indication
- Electronic dry run protection
- Pressure sensor on both sides
- Vibration damping
- Electric motor, protection class IP55, efficiency class IE5 according to IEC 60034-30
- Error message contact per pump

Application:

- Pressure increase
- Pumping of drinking water, process water, cooling water & liquids that do not chemically or mechanically attack the materials

Scope of delivery:

- Pumps with control
- Expansion tank
- Base plate for safe installation
- Discharge side gate valve per pump
- Suction side gate valve per pump
- Suction and pressure side collecting pipe made of stainless steel

Technical data:

Art.no.	U [V]	P ₁ [W]	I _n [A]	n [min ⁻¹]	Q _{max} [m ³ /h]	H _{max} [m]	P0	L [mm]	W [mm]	H [mm]	Weight [kg]
21924	400	1100	3	2900	6,5	61	G11/2	595	655	1340	118

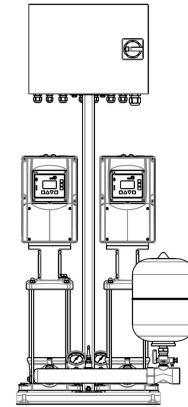
Product benefits:

- Energy-efficient operation and constant pressure through speed control of all pumps
- Suitable for drinking water due to production under strict hygienic conditions (German drinking water approval)
- Simple and fast commissioning due to ready-to-connect, pre-assembled and tested system
- Corrosion-resistant due to powder-coated materials and stainless steel
- Operational safety due to built-in dry-running protection
- Avoidance of damage to the piping system in the 3~400 V version through piping filling function
- Remote monitoring of the plant through connection to building control system

Characteristics:

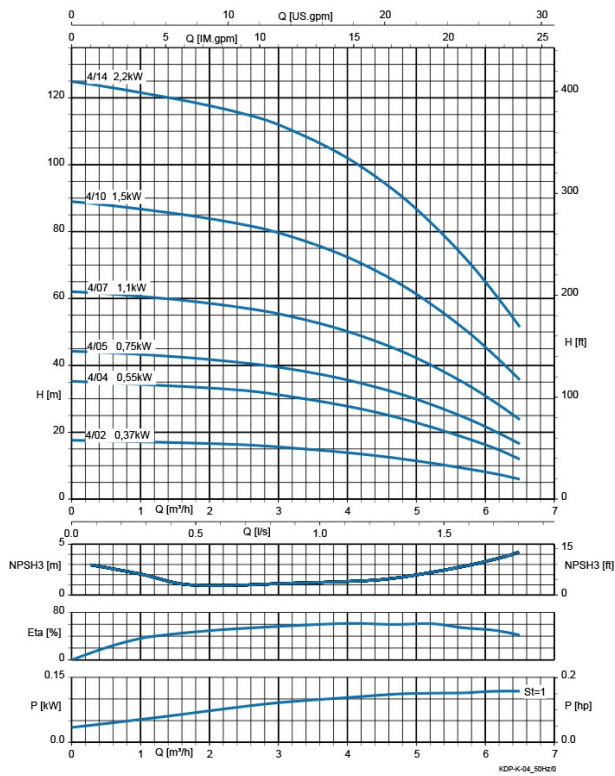

Materials:

Seal motor:	mechanical seal
Material pump housing:	stainless steel 1.4308

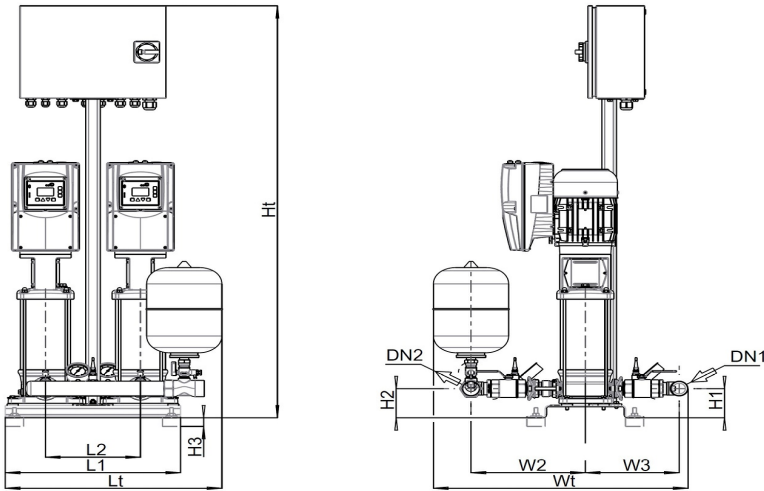
Dimensions:

Pump(s)	Type	Stages	DN 1	DN 2	L1 [mm]	L2 [mm]	Lt [mm]	H1 [mm]	H2 [mm]	Ht [mm]	W1 [mm]	W2 [mm]	W3 [mm]	Wt [mm]
2	02	05	G 1 1/2	G 1 1/2	480	260	595	95	95	1040	320	291	235	655
2	02	08	G 1 1/2	G 1 1/2	480	260	595	95	95	1340	320	291	235	655
2	02	10	G 1 1/2	G 1 1/2	480	260	595	95	95	1340	320	291	235	655
2	02	14	G 1 1/2	G 1 1/2	480	260	595	95	95	1340	320	291	235	655
2	04	02	G 1 1/2	G 1 1/2	480	260	595	95	95	1040	320	291	235	655
2	04	04	G 1 1/2	G 1 1/2	480	260	595	95	95	1040	320	291	235	655
2	04	05	G 1 1/2	G 1 1/2	480	260	595	95	95	1040	320	291	235	655
2	04	07	G 1 1/2	G 1 1/2	480	260	595	95	95	1340	320	291	235	655
2	04	10	G 1 1/2	G 1 1/2	480	260	595	95	95	1340	320	291	235	655
2	04	14	G 1 1/2	G 1 1/2	480	260	595	95	95	1340	320	291	235	655
2	06	02	G 1 1/2	G 1 1/2	480	260	595	95	95	1040	320	305	249	683
2	06	03	G 1 1/2	G 1 1/2	480	260	595	95	95	1040	320	305	249	683
2	06	05	G 1 1/2	G 1 1/2	480	260	595	95	95	1040	320	305	249	683
2	06	07	G 1 1/2	G 1 1/2	480	260	595	95	95	1340	320	305	249	683
2	06	10	G 1 1/2	G 1 1/2	480	260	595	95	95	1340	320	305	249	683
2	06	14	G 1 1/2	G 1 1/2	480	260	595	95	95	1340	320	305	249	683
2	10	02	G 2	G 2	640	340	740	125	125	1040	360	373	297	805
2	10	03	G 2	G 2	640	340	740	125	125	1340	360	373	297	805
2	10	04	G 2	G 2	640	340	740	125	125	1340	360	373	297	805
2	10	06	G 2	G 2	640	340	740	125	125	1340	360	373	297	805
2	10	08	G 2	G 2	640	340	740	125	125	1340	360	373	297	805
2	10	11	G 2	G 2	640	340	740	125	125	1340	360	373	297	805
2	15	02	NW65 PN 16	NW65 PN 16	640	340	715	125	125	1340	360	408	332	938
2	15	03	NW65 PN 16	NW65 PN 16	640	340	715	125	125	1340	360	408	332	938
2	15	04	NW65 PN 16	NW65 PN 16	640	340	715	125	125	1340	360	408	332	938
2	15	06	NW65 PN 16	NW65 PN 16	640	340	715	125	125	1590	360	408	332	938
2	15	08	NW65 PN 16	NW65 PN 16	640	340	715	125	125	1590	360	408	332	938