

**Features:**

- Fully automatic pressure boosting system
- Speed controlled
- Base plate version
- Membrane pressure vessel approved for drinking water on the pressure side as a control vessel, flow through according to DIN 4807-5, with stopcock and drainage valve
- 3 vertical high-pressure pumps with speed control
- Reliable operation due to hydraulic components made of stainless steel / brass
- Check valve for each pump
- Pressure gauge for pressure indication
- Electronic dry run protection
- Pressure sensor on both sides
- Vibration damping
- Electric motor, protection class IP55, efficiency class IE5 according to IEC 60034-30
- Error message contact per pump

**Application:**

- Pressure increase
- Pumping of drinking water, process water, cooling water & liquids that do not chemically or mechanically attack the materials

**Scope of delivery:**

- Pumps with control
- Expansion tank
- Base plate for safe installation
- Discharge side gate valve per pump
- Suction side gate valve per pump
- Suction and pressure side collecting pipe made of stainless steel

**Technical data:**

Art.no.	U [V]	P <sub>1</sub> [W]	I <sub>n</sub> [A]	n [min <sup>-1</sup> ]	Q <sub>max</sub> [m <sup>3</sup> /h]	H <sub>max</sub> [m]	P0	L [mm]	W [mm]	H [mm]	Weight [kg]
21964	400	3000	7,6	2900	13	91	G2	1080	805	1340	248

**Product benefits:**

- Energy-efficient operation and constant pressure through speed control of all pumps
- Suitable for drinking water due to production under strict hygienic conditions (German drinking water approval)
- Simple and fast commissioning due to ready-to-connect, pre-assembled and tested system
- Corrosion-resistant due to powder-coated materials and stainless steel
- Operational safety due to built-in dry-running protection
- Avoidance of damage to the piping system in the 3~400 V version through piping filling function
- Remote monitoring of the plant through connection to building control system

**Characteristics:**

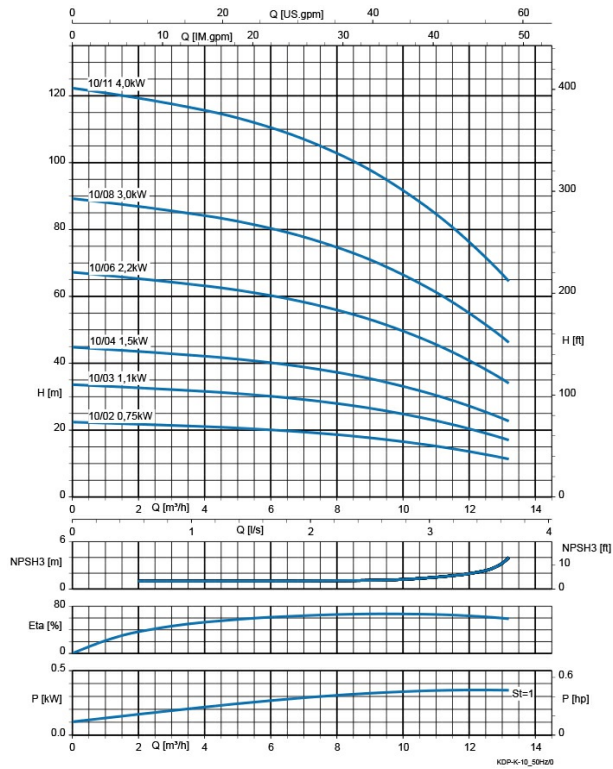

**Materials:**

Seal motor:	mechanical seal
Material pump housing:	stainless steel 1.4308

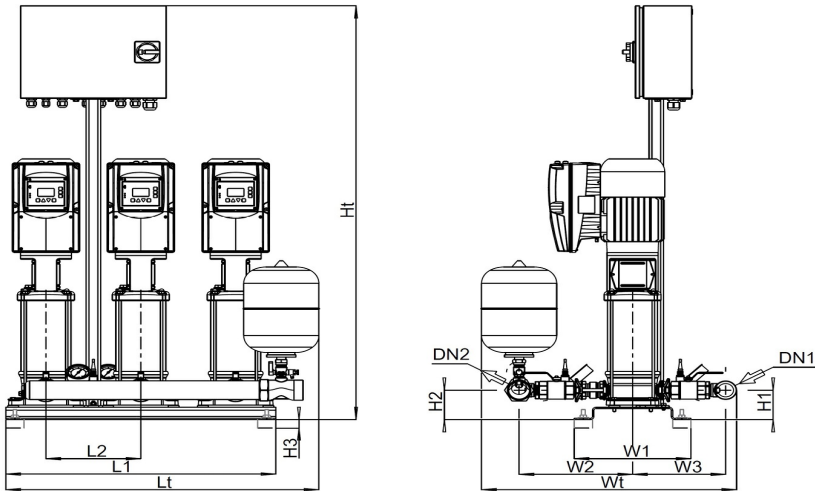
**Dimensions:**

Pumps(s)	Type	Stages	DN 1	DN 2	L1 [mm]	L2 [mm]	Lt [mm]	H1 [mm]	H2 [mm]	Ht [mm]	W1 [mm]	W2 [mm]	W3 [mm]	Wt [mm]
3	02	05	G 1 1/2	G 1 1/2	740	260	855	95	95	1040	320	291	235	655
3	02	08	G 1 1/2	G 1 1/2	740	260	855	95	95	1340	320	291	235	655
3	02	10	G 1 1/2	G 1 1/2	740	260	855	95	95	1340	320	291	235	655
3	02	14	G 1 1/2	G 1 1/2	740	260	855	95	95	1340	320	291	235	655
3	04	02	G 1 1/2	G 1 1/2	740	260	855	95	95	1040	320	291	235	655
3	04	04	G 1 1/2	G 1 1/2	740	260	855	95	95	1040	320	291	235	655
3	04	05	G 1 1/2	G 1 1/2	740	260	855	95	95	1040	320	291	235	655
3	04	07	G 1 1/2	G 1 1/2	740	260	855	95	95	1340	320	291	235	655
3	04	10	G 1 1/2	G 1 1/2	740	260	855	95	95	1340	320	291	235	655
3	04	14	G 1 1/2	G 1 1/2	740	260	855	95	95	1340	320	291	235	655
3	06	02	G 2	G 2	740	260	855	95	95	1040	320	311	255	701
3	06	03	G 2	G 2	740	260	855	95	95	1340	320	311	255	701
3	06	05	G 2	G 2	740	260	855	95	95	1340	320	311	255	701
3	06	07	G 2	G 2	740	260	855	95	95	1340	320	311	255	701
3	06	10	G 2	G 2	740	260	855	95	95	1340	320	311	255	701
3	06	14	G 2	G 2	740	260	855	95	95	1340	320	311	255	701
3	10	02	G 2	G 2	980	340	1080	125	125	1040	360	373	297	805
3	10	03	G 2	G 2	980	340	1080	125	125	1340	360	373	297	805
3	10	04	G 2	G 2	980	340	1080	125	125	1340	360	373	297	805
3	10	06	G 2	G 2	980	340	1080	125	125	1340	360	373	297	805
3	10	08	G 2	G 2	980	340	1080	125	125	1340	360	373	297	805
3	10	11	G 2	G 2	980	340	1080	125	125	1340	360	373	297	805
3	15	02	NW65 PN 16	NW65 PN 16	980	340	1055	125	125	1340	360	408	332	938
3	15	03	NW65 PN 16	NW65 PN 16	980	340	1055	125	125	1340	360	408	332	938
3	15	04	NW65 PN 16	NW65 PN 16	980	340	1055	125	125	1340	360	408	332	938
3	15	06	NW65 PN 16	NW65 PN 16	980	340	1055	125	125	1340	360	408	332	938
3	15	08	NW65 PN 16	NW65 PN 16	980	340	1055	125	125	1340	360	408	332	938